



AC-LITE

30 BAY CYCLE CHARGING CART

USER MANUAL

Designed to charge, store and transport up to 30 Chromebooks, laptops or tablets up to 14 inches.

Specifications:

Model		AC-LITE
Cart Dimensions	Inch	42.8 (H) x 25 (W) x 24.3 (D)
	mm	1087 (H) x 635 (W) x 617 (D)
Shelf Dimensions	Inch	16.25 (W) x 10.69 (H) & Divider Spacing: 1.43
	mm	413 (W) x 272 (H) x Divider Spacing: 36
Product weight (Without Devices)		160 lbs (72.57 kg)
Shipping Weight		167 lbs (75.75 kg)
Capacity		30 bays (3 shelves, 10 bays/shelf)
Supported Devices		Devices up to 14 Inch
Power Specifications (For carts sold within North America)		AC IN/ Power Strip: 110V AC, 50/60Hz, 10A Maximum power: 1400W
Power Specifications (For carts sold outside North America)		AC IN/ Power Strip: 100-240V AC, 50/60Hz, 10A Maximum power: 2400W
Charging Type		Economical Cycle Charging Cart
Security		Front door 3 point mechanism with lock hole
Casters		Four 4 inch (102 mm) Casters; 2-Locking, 2- Directional
Work Platform Loading		55.1 lbs (25 kg)
Shelf Loading (ea.)		110.2 lbs (50 kg)
Adapter Shelves Loading (ea.)		6.6 lbs (3 kg)
Working Temperature		0°- 30°c
Working RH%		10% - 90%
Storage Temperature		-40°- 60°C Temp
Storage RH%		5% - 95%
Warranty		Lifetime Frame, 2 Years Components, 2 Year Electronics

Specifications subject to change without notice.

This manual covers the following models and part numbers.
 The manual is based upon the North American 110V product offering.
 Refer to the part numbers below and cord end diagrams for your specific region.

MODEL# AC-LITE

SKU	DESCRIPTION
AC-LITE	AC-LITE, 30 Bay, Economical Cycle Charging Cart - 110V NA (Legacy Number)
CRT-LTE-C30L-D	AC-LITE, 30 Bay, Economical Cycle Charging Cart - 110V NA
CRT-LTE-C30L-E	AC-LITE, 30 Bay, Economical Cycle Charging Cart - 220V EU
CRT-LTE-C30L-U	AC-LITE, 30 Bay, Economical Cycle Charging Cart - 220V UK
CRT-LTE-C30L-A	AC-LITE, 30 Bay, Economical Cycle Charging Cart - 220V AU
CRT-LTE-C30L-S	AC-LITE, 30 Bay, Economical Cycle Charging Cart - 220V SW

Power Cords and Sockets for Specific Region:

US / Canada

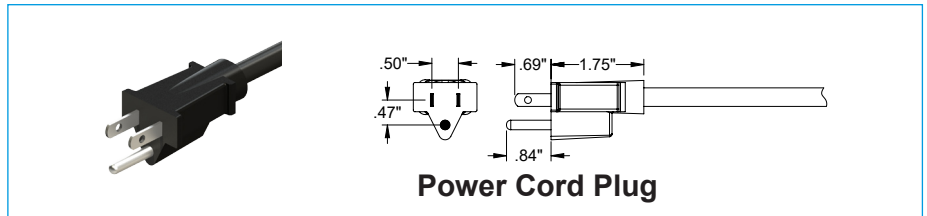
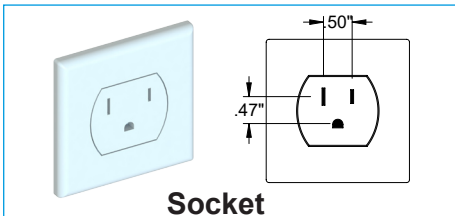

United Kingdom

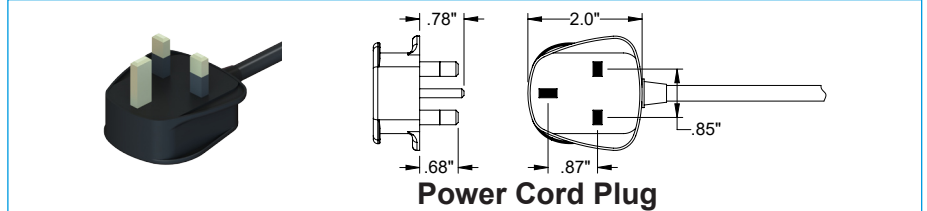
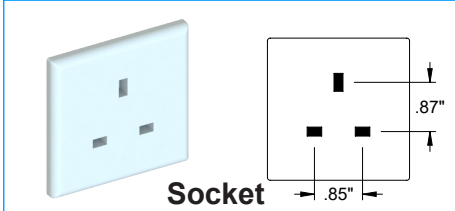

European

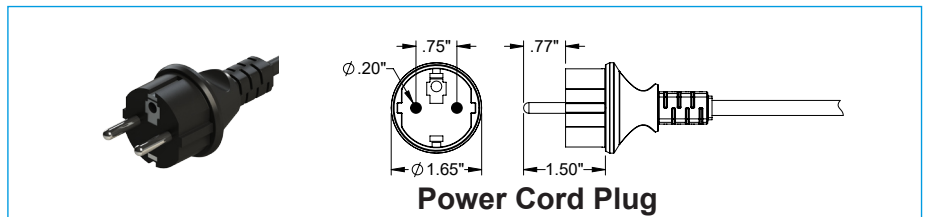
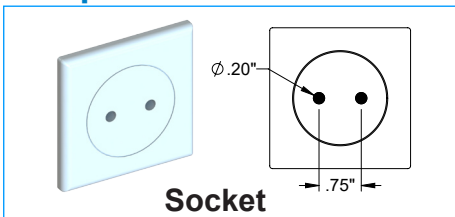

Australian

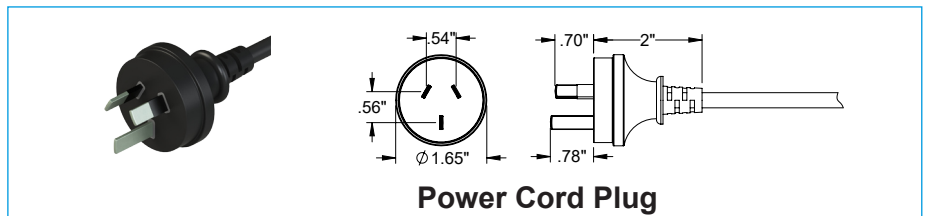
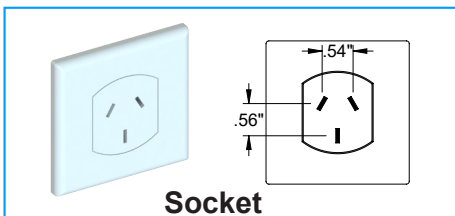

Switzerland Type-J

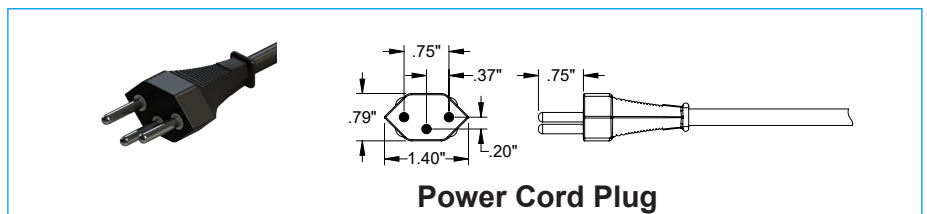
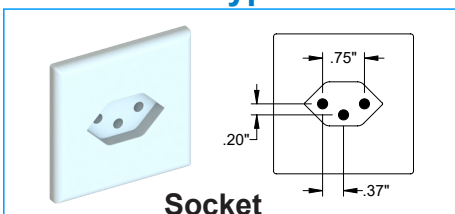

Product Information

The AC-LITE is designed to charge and store up to 30 Chromebooks, Laptops or tablets.

NOTE: Please review this guide before installing devices and to learn how to safely use your cart.



Push Handle



Keyed Door
Lock Latch



4" Swivel / Directional Casters



4" Swivel / Lock Casters

Front View of Cart

- If the device (Laptop / Chromebook) thickness is more than the gap between the dividers, remove one of the dividers to create enough space for your device.

External Power Button

Removable Dividers

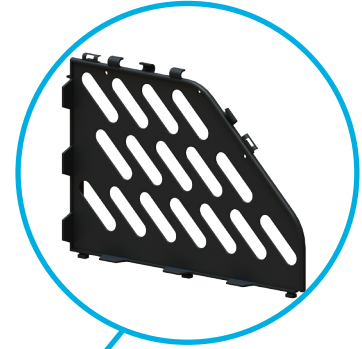
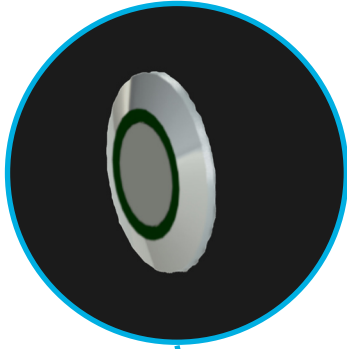

Front View of Cart

- Removable adapter baskets are used to hold the device accessories, power adapter and allow power cables.

Removable Adapter Basket

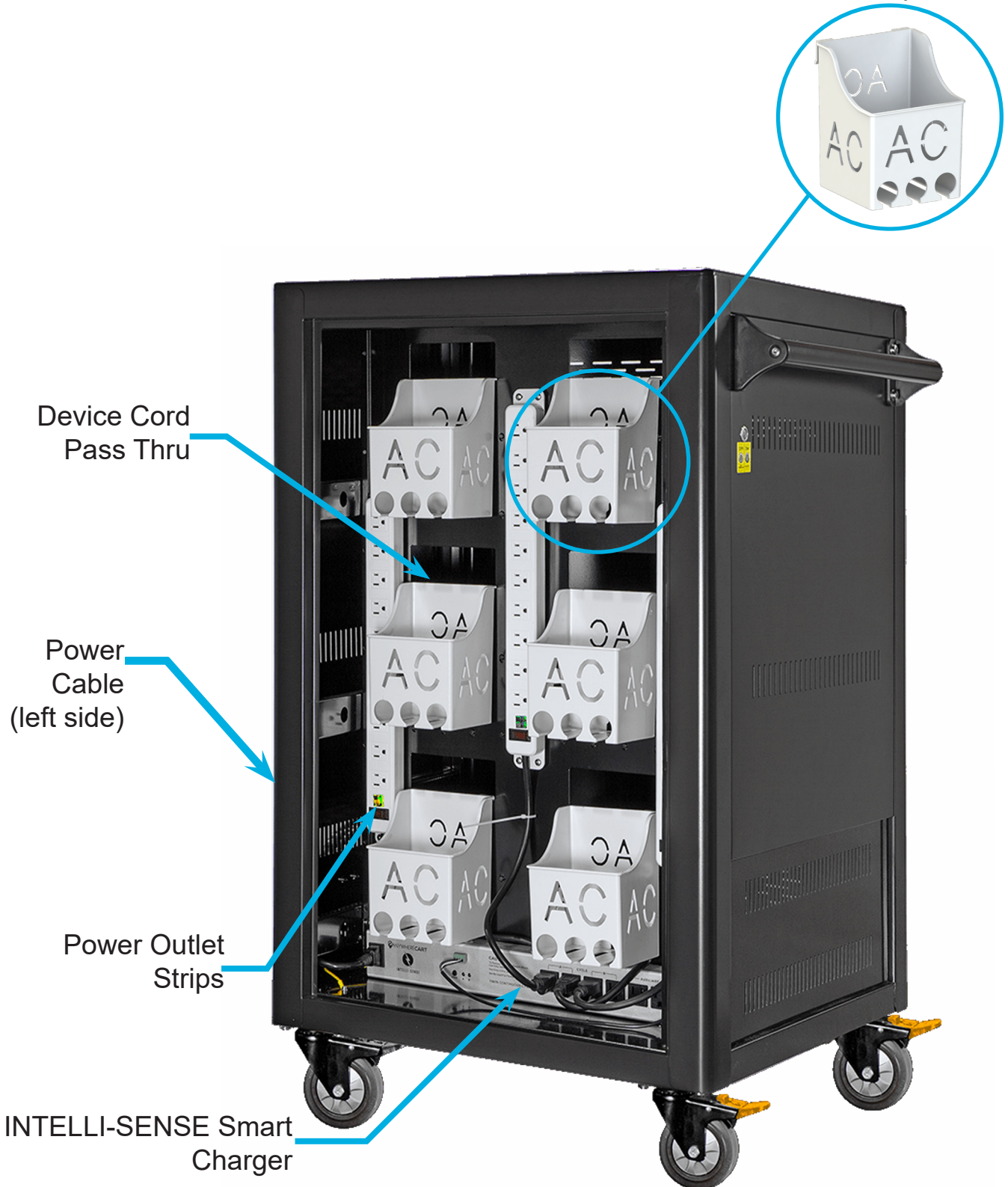

Rear View of Cart

INSTALLING THE HANDLE:



- Locate the narrow cardboard box containing the handle rod, handle bolts, mounting brackets & hex wrenches.

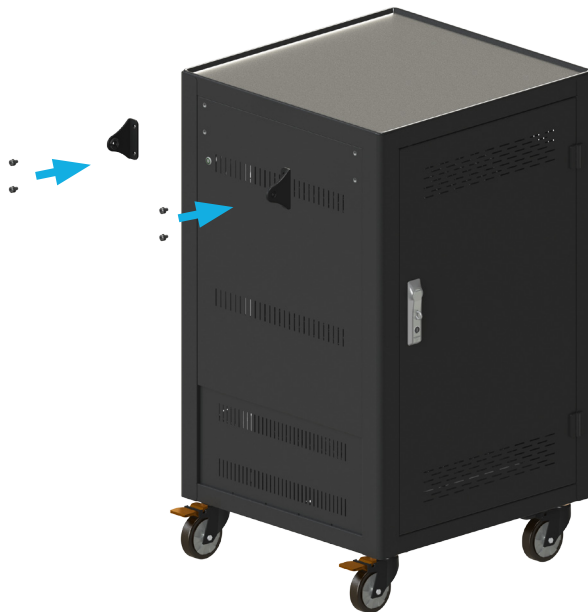

Handle Bolts



- On top of the cart, locate the threaded holes for the handle.

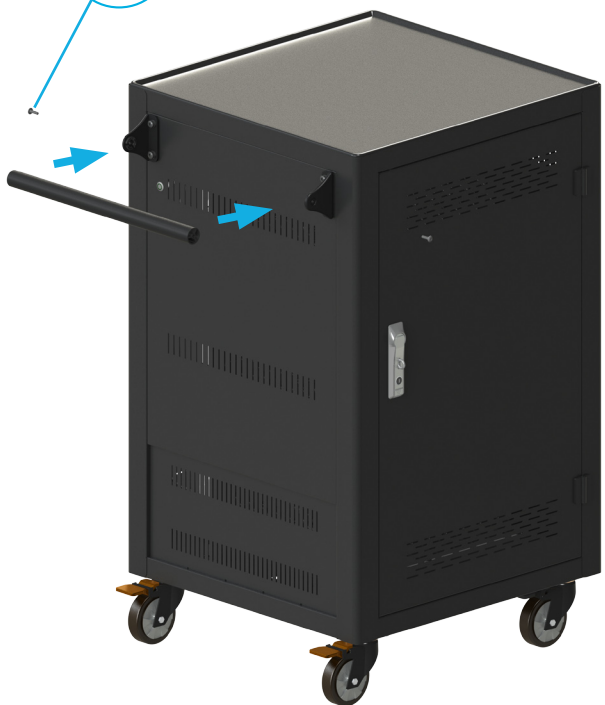

- Using the larger hex wrench, attach and tighten both the left and right side handle mounting bracket to the top of the cart using 4 large bolts.
- Fit the handle rod between the bracket and tighten using the smaller hex wrench and handle bolts.

SETTING UP DEVICES (FRONT):



Step-1: Using a ruler, measure the thickness of your device.



Step-2: If device is thicker than 1", locate & remove thumbscrews on shelf.



Step-3: Remove Retaining Strip.



Step-4: Pull forward, then up, to remove the Divider.



Step-5: Adjust spacing as needed.



Step-6: Place Retaining Strip in position & replace thumbscrews.

SETTING UP DEVICES (BACK) :



Step-1: Remove basket by pulling upward first, then pull forward.



Step-2: If your device power adapters are “brick” style, feed power cables through holes and place no more than 6 into a basket.



Step-3: Hook basket(s) in place & distribute power cords so that all power strips have an equal number of devices plugged in.

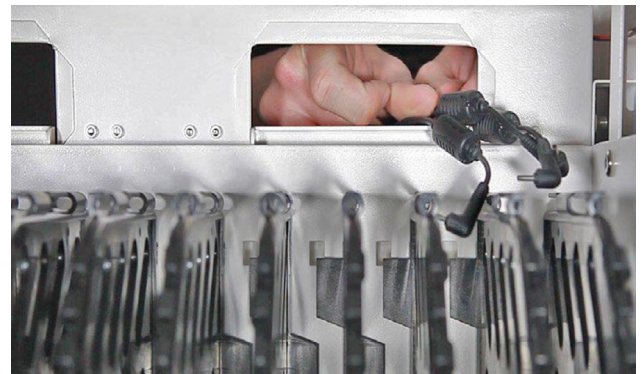

Step-4: Feed device cables into pass-thru slots to front of cart.

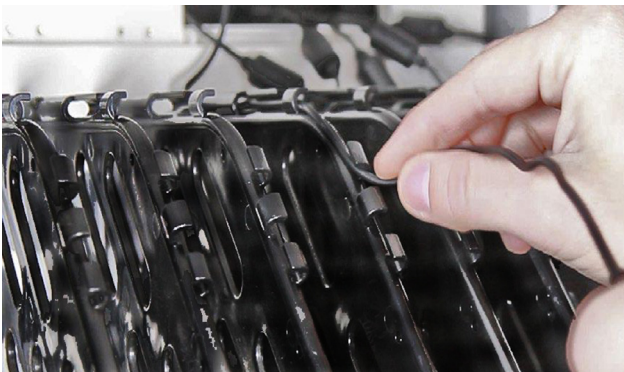

Step-5: Working up front, weave device cables into divider tabs.

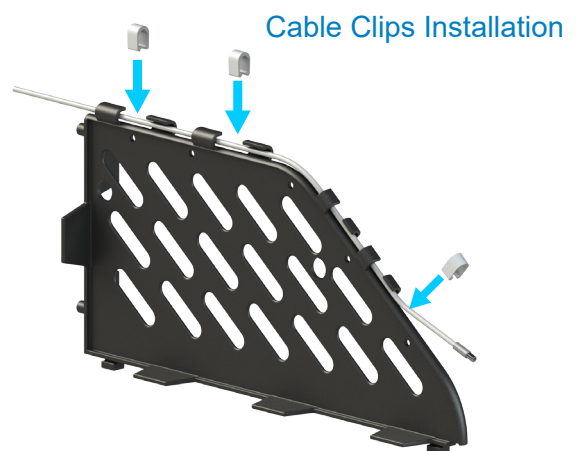

Step-6: Use the supplied Cable Clips to fasten each cable to the divider by pressing down firmly, securing the cable in place.

15 Minute Cycle Timer

THE ELECTRICAL SYSTEM IS DESIGNED TO HANDLE A MAXIMUM OF 14 AMPS.

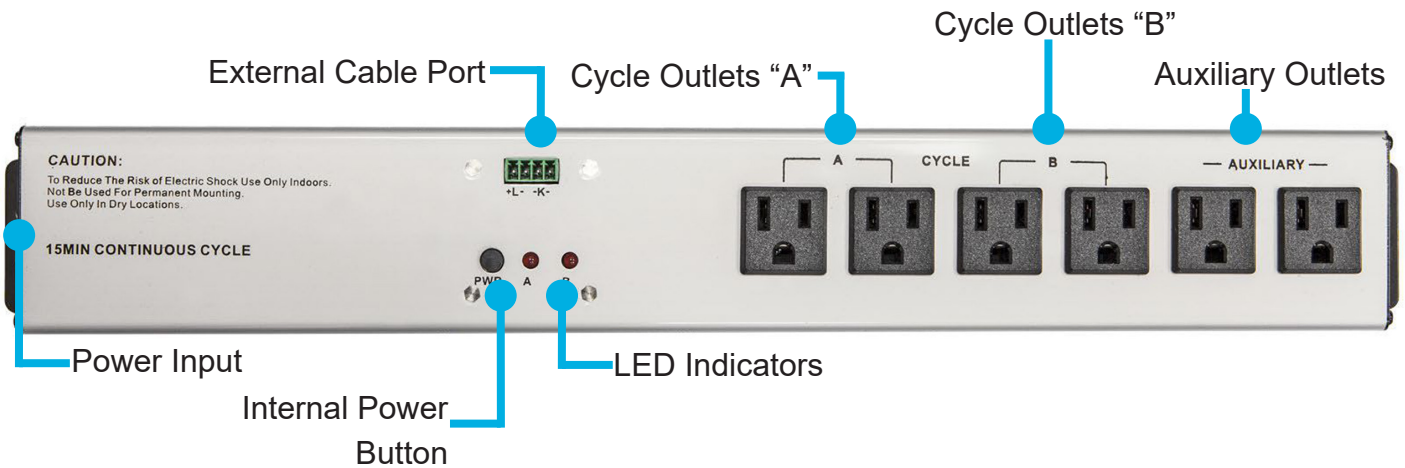

Within 5 seconds of plugging in your cart's power cord, the 15 Minute Cycle Timer on the AC-LITE will charge half of the devices (15 Devices) in your cart for 15 minutes. It will start to charge devices which are plugged into power strips on the "A" circuit. Then, after 15 minutes, devices which are on the "B" circuit will charge. This continuous cycle will remain in operation until your cart's External Illuminated LED Power Button is pressed and no longer illuminates.

Cycle "A"



Cycle "B"



NOTE:

If wattage exceeds 14 Amps or about 1400 Watts at one time, the charging system may not operate correctly.

Review your device's AC Adapter wattage, multiplying it by 15.

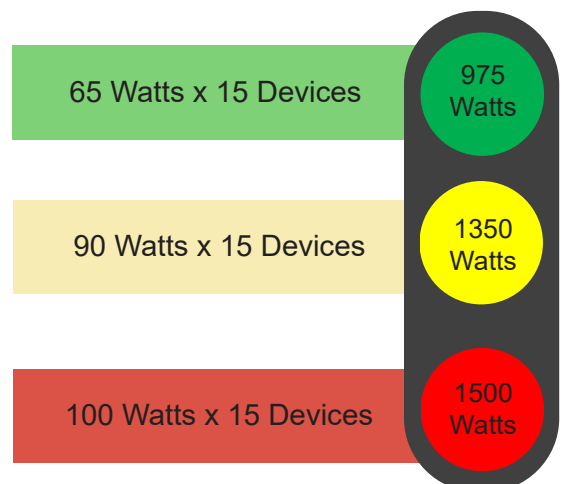

Casters Positions

This cart is equipped with Casters that have an “Orange” color foot pedal.

Engage the Directional Locking Casters by pressing the orange foot pedal down. Your cart will now easily track in a straight line.

Release the Direction Lock by lifting up on the foot pedal. The cart will have its full swivel motion restored.



“Engage the “BLACK” foot pedal to securely lock the wheels, keeping the cart safely in place.”

“Engage the “ORANGE” foot pedal for a seamless and precise straight-line movement, making navigation a breeze.”

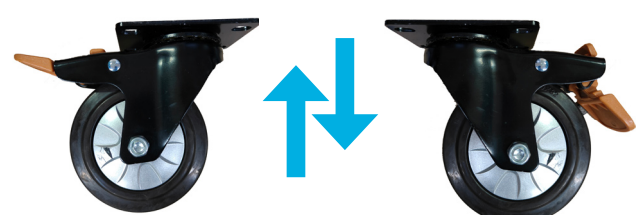
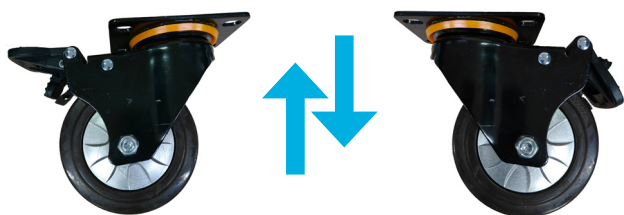

“With a simple release of the “BLACK” foot pedal, allowing you to navigate effortlessly with unparalleled flexibility.”

“With a simple release of the “ORANGE” foot pedal, embrace a world of precision and grace in your swivel motion, making maneuvering a breeze.”

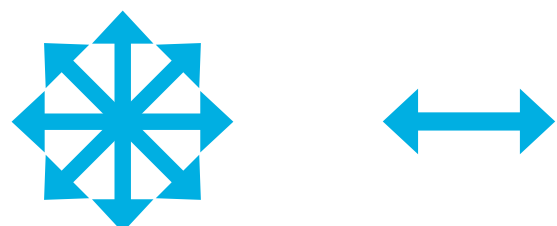

Safety Instructions

	Caution
	Notice

**THIS IS NOT A TOY.
ALWAYS FOLLOW SAFETY INSTRUCTIONS.**

	Danger
	Warning

DO NOT Pull the cart using power cord

Important

THE ELECTRICAL SYSTEM IS DESIGNED TO HANDLE A MAXIMUM OF 1400 WATTS per side. If wattage exceeds 1400W at one time, charging system may not operate correctly. Remove devices until the total wattage is under 1400W.

Don't connect the cart with broken electrical components.

DO NOT place liquids on or near the cart

- ALWAYS move the cart slowly and be aware of your surroundings
- ALWAYS latch doors before moving the cart
- Repairs should always be performed by a qualified electrician.
- Set the power switch to the OFF position before you unplug the unit from the wall, plug the unit into the wall, or plug in devices.
- If external devices are set on top of the cart, remove them before rolling cart around.
- DO NOT block the ventilation holes used for air circulation.

DO NOT touch any part of the electrical system while plugged in.

DO NOT attempt to move down stairs.

For warranty claims, please have the following information ready, then visit www.powertechnologies.com to create a help ticket.

DO NOT use an extension cord with this unit.

DO NOT Roll the cart over the power cord

Serial Number:

DO NOT allow children to move or climb.

DO NOT ride or run with the cart.



Charging System Type:

Date Of Purchase:

Reseller Name:

PO Number:

ONLY ADULTS should move the cart.

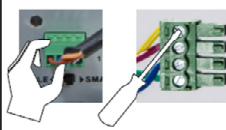
TROUBLE	Indication	Possible Cause	How to check	Where to check	Remedy
External LED Button is flashing green and devices are not charging	Overload Protection Mode has been activated	Wattage exceeded 1400 Watts at one time	Multiply your device's AC adapter wattage by 15.		Reduce the number of devices if necessary and resume charging
System does not power on	External LED Button does not flash	Power cord is not secured properly	<ul style="list-style-type: none"> Check the main Power Cord into the Power Input port located on the left side of the Charging System if it is secured properly. Plug the cart into a wall outlet and press the internal Power Button labeled PWR directly on the Charging System. Remove power cord and plug in a PC monitor style IEC Power Cord. 		If one or more Power Strips no longer works, replace as needed
Few /All Devices do not get charged works	No visible indication	Power cord failure	<ul style="list-style-type: none"> Open the rear panel door and locate the 3 vertically mounted Power Strips. Verify each switch is in the "RESET" position, not the "OFF" position. Using an extension cord, test each Power Strip by unplugging each cord from the charging system and plugging them into the extension cord. 		Replace the power cord if found faulty
External Power Button not works	External LED Button does not flash	Power Strip failure	<ul style="list-style-type: none"> With your cart plugged in, open the rear panel door and press the internal Power Button labeled PWR on the charging system. Plug the External Cable back in and press the External Power Button. 		<ul style="list-style-type: none"> If your cart powers on, unplug the External Cable from Charging System Using a small flat head screwdriver, ensure all individual wires are secure. Replace the power button if found faulty.

For further information on this product and others, contact Power Technologies at.

Power Technologies
42035 Zevo Dr
Temecula, CA 92590+
888.650.4488

support@powertechnologies.com

www.powertechnologies.com
